

KAC-8102D/8152D KAC-9102D/9152D

SERVICE MANUAL

KENWOOD

Kenwood Corporation

© 2005-3 PRINTED IN JAPAN
B53-0252-00 (N) 1708

KAC-9152D
(E type, M type)

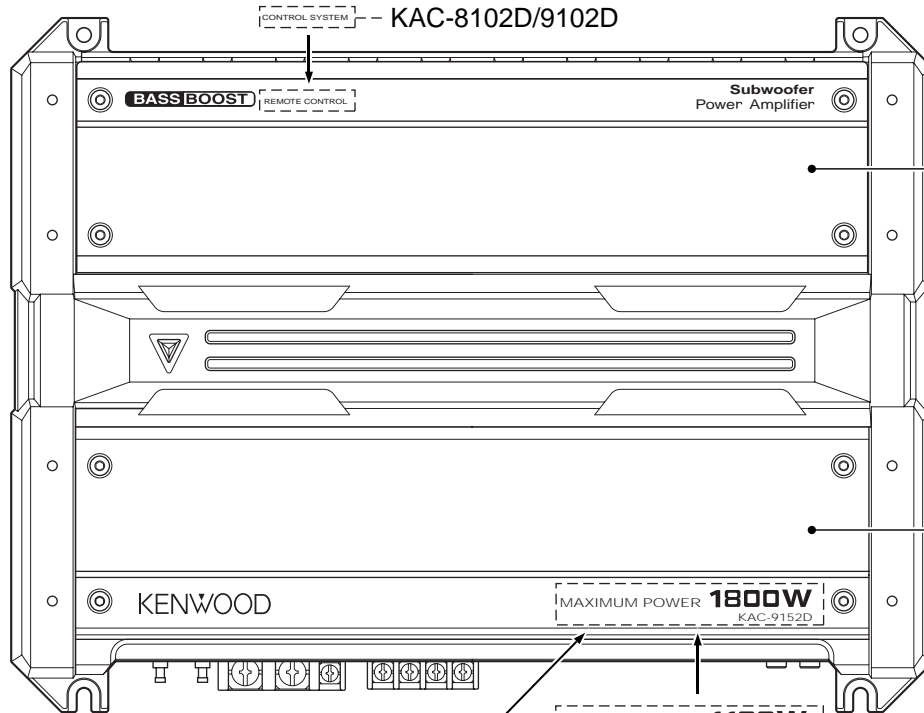

Dressing Panel
(A21-4465-02)
: KAC-8152D/9152D
(A21-4466-02)
: KAC-8102D/9102D

Dressing Panel
(A21-4471-02)
: KAC-9152D(K type)
(A21-4472-02)
: KAC-9102D
(A21-4473-02)
: KAC-8152D(K type)
(A21-4474-02)
: KAC-8102D
(A21-4522-12)
: KAC-9152D(E/M type)
(A21-4523-12)
: KAC-8152D(E/M type)

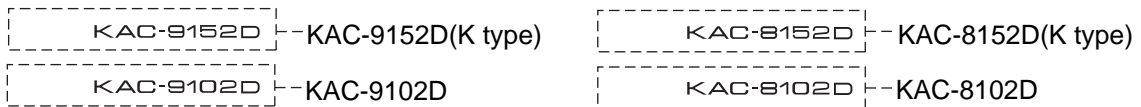

Fuse (40A) (F52-0016-05) : KAC-8102D/8152D
Fuse (30A) (F52-0015-05) : KAC-9102D/9152D

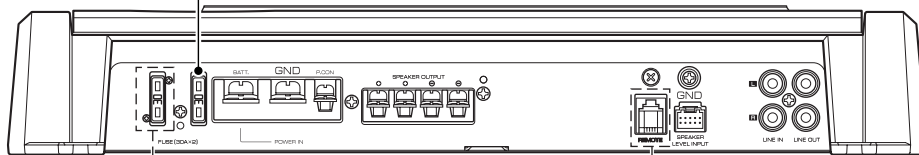

Fuse (30A) (F52-0015-05) : KAC-9102D/9152D

Except KAC-8102D/9152D

Except KAC-8102D/9152D

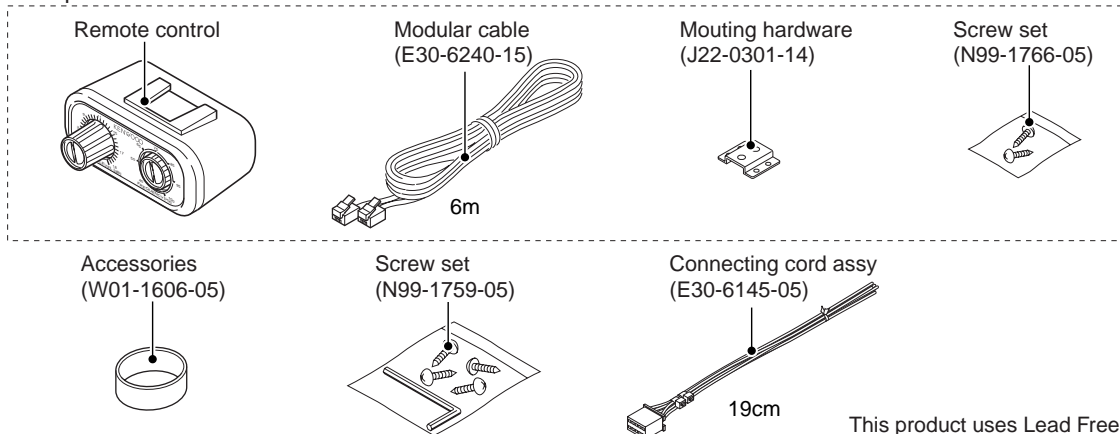

This product uses Lead Free solder.



BLOCK DIAGRAM

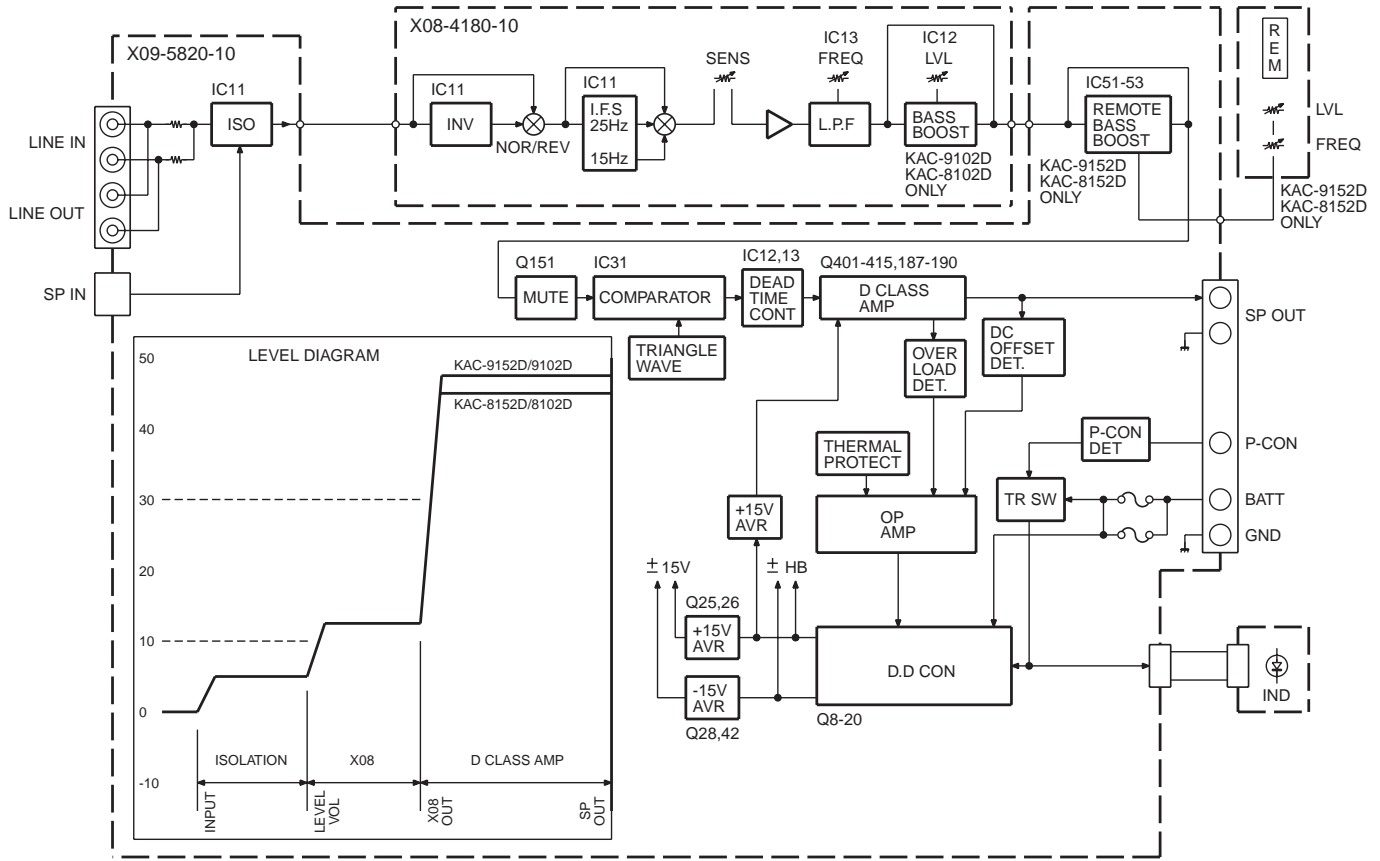

COMPONENTS DESCRIPTION

● PREAMPLIFIER UNIT (X08-4180-1x)

Ref. No.	Application / Function	Operation / Condition / Compatibility
IC11 (1/2)	INFRA SONIC FILTER	Cutting super-low area of voice signals
IC11 (2/2)	INVERTER	Reversing voice signal phase
IC12 (1/2)	OP AMP	Voltage amplification, buffer
IC12 (2/2)	BASS BOOST	High-boost (variable levels)
IC14,15	BASS BOOST	High-boost (variable levels)
IC13	LOW PASS FILTER	Cutting high range of voice signal

● AUDIO UNIT (X09-5820-1x)

Ref. No.	Application / Function	Operation / Condition / Compatibility
IC1	DC/DC converter IC	Create drive signal for switching element
IC2 (1/2)	Differential amplifier	Detection of temperature, DC, and excess current and hold protection for a certain time
IC2 (2/2)	Differential amplifier	Containing excess voltage of $\pm B$
IC11	Isolation amplifier	Prevention of noise by the electric potential difference of GND
IC12,13	NAND	Generation and forming of Dclass section reversal waveform and dead time
IC31	Comparator	Digitalize signal by comparing analog signal and triangular wave
IC32 (1/2)	Triangular wave generation	Reference signal generation for converting analog signals to digital signals
IC32(2/2)	Error amplifier	Error compensation by feedback from output
IC51~53	OP amp, electronic volume	Frequency, variable level BASS BOOST
IC61,62	Comparator	Detection of short-circuiting of SP output and determine excess current for triggering protection
Q1-3	PCON switch	Turns on the circuit when ON-signal is impressed on PCON
Q4,5	Mute	Mute drive signal generation, Turn LED off
Q8~11	Gate drive	DC/DC converter FET gate drive
Q12-20	DC/DC converter	DC/DC converter switching
Q25,26,28	AVR	$\pm 15V$ AVR
Q29,30	Tracking when $\pm 15V$ AVR is OFF	Adjusts $-15V$ AVR falling to $+15V$ AVR falling
Q36	DC/DC converter ON/OFF control	Stops DC/DC converter switching when protection is triggered
Q37~38	DC/DC converter pulse ON/OFF control	ON/OFF of DC/DC converter drive waveform
Q41	4.4V AVR	Vref 5V reference AVR
Q42	AVR	$\pm 15V$ AVR
Q43	DC/DC converter ON/OFF control	Stops DC/DC converter switching when protection is triggered
Q151	Mute	Turning off voice signal
Q187~190	Electric power amplification	Dclass large current switching
Q401~415	Pulse amplification and rectifying	Generation of signal for driving Dclass final FET
Q416	15V AVR	Integration AVR for obtaining Dclass High+B
Q417,418	Control of ON/OFF of electric power amplification section	Makes the electric power amplification section non-operative for 1.2 seconds when the power is turned on and when protection is triggered
Q501	Emitter follower	Generation of temperature compensation reference voltage for control of electronic volume
Q601,602	Comparator	Detection of short-circuiting of SP output and determine excess current for triggering protection
Q603	DC/DC converter control	Convey IC62 ⑦ pin output, result of excess current detection, to IC2 and stop the DC/DC converter
Q604~607	Electric current and voltage conversion	Conversion of current to voltage of the current flowing to final
Q608~611	Latch circuit	Detection and holding of output excess voltage

PC BOARD (FOIL SIDE VIEW)

AUDIO UNIT X09-5820-1x A/2 (J76-0072-11)

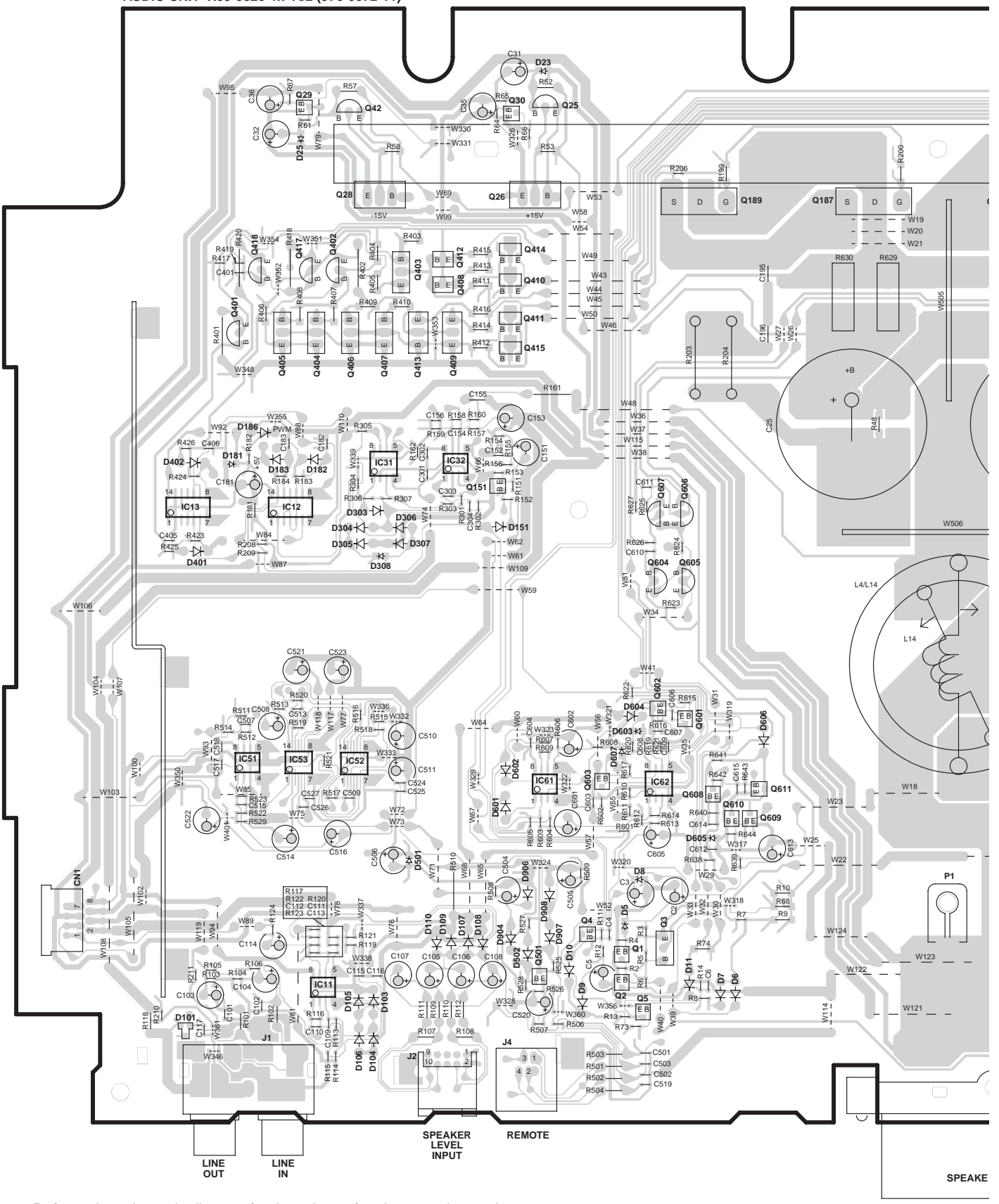

Refer to the schematic diagram for the values of resistors and capacitors.

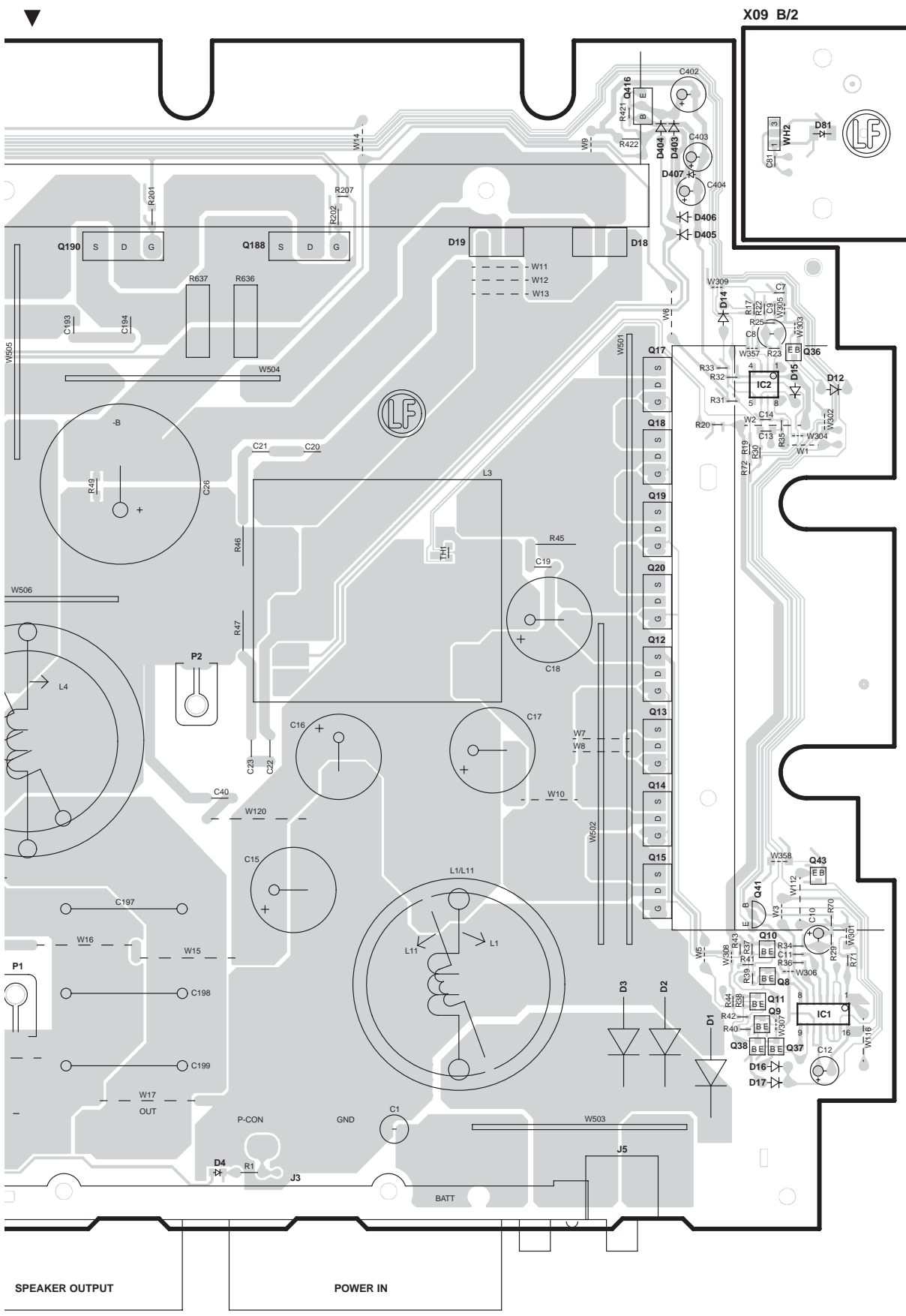

X09-5820-1x

Ref. No.	Address
IC1	6I
IC2	3I
IC11	6B
IC12	4B
IC13	4B
IC31	4C
IC32	4C
IC51	5B
IC52	5B
IC53	5B
IC61	5C
IC62	5D
Q1	6D
Q2	6D
Q3	6D
Q4	6D
Q5	6D
Q8	6I
Q9	6I
Q10	5I
Q11	6I
Q12	4H
Q13	4H
Q14	5H
Q15	5H
Q17	3H
Q18	3H
Q19	3H
Q20	4H
Q25	2C
Q26	2C
Q28	2B
Q29	2B
Q30	2C
Q36	3I
Q37	6I
Q38	6I
Q41	5I
Q42	2C
Q43	5I
Q151	4C
Q187	2E
Q188	2G
Q189	2D
Q190	2F
Q401	3B
Q402	3B
Q403	3C
Q404	3B
Q405	3B
Q406	3B
Q407	3C
Q408	3C
Q409	3C
Q410	3C
Q411	3C
Q412	3C
Q413	3C
Q414	3C
Q415	3C
Q416	2H
Q417	3B
Q418	3B
Q501	6C
Q601	5D
Q602	5D
Q603	5D
Q604	4D
Q605	4D
Q606	4D
Q607	4D
Q608	5D
Q609	5D
Q610	5D
Q611	5D

SPEAKER OUTPUT

POWER IN

PC BOARD (FOIL SIDE VIEW)

PREAMPLIFIER UNIT X08-4180-1x A/2 (J76-0068-02)

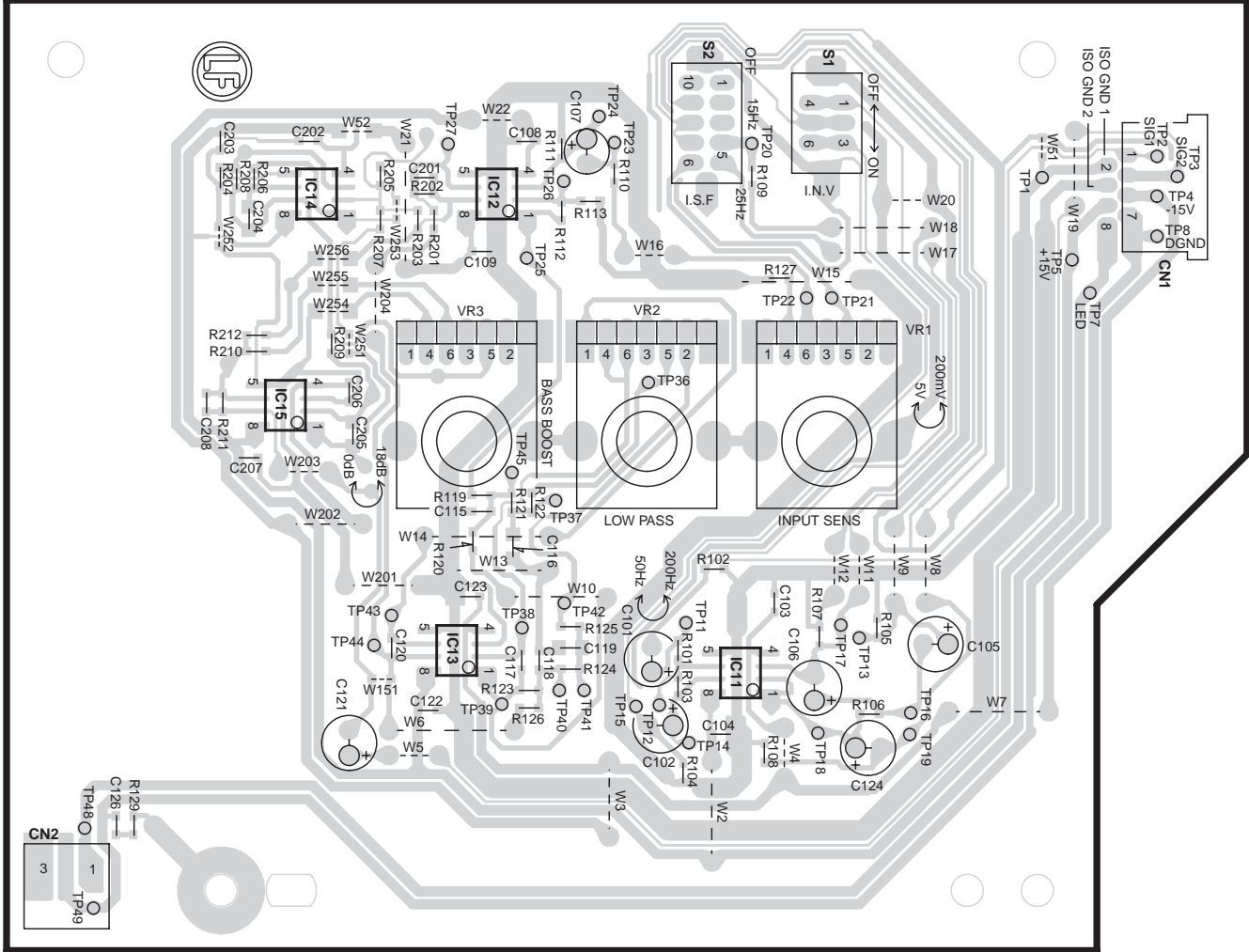

X08 B/2

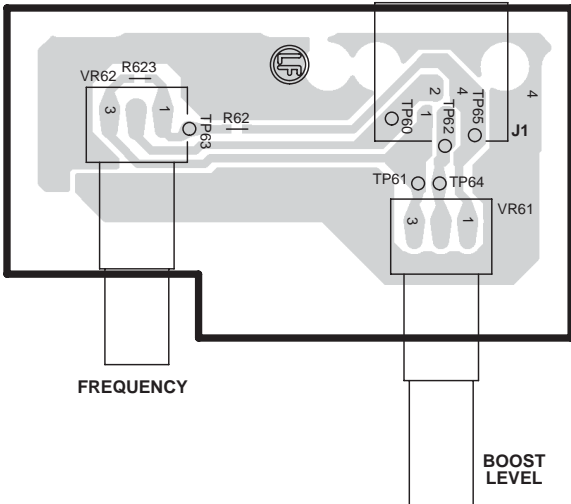

X08-4180-1x

Ref. No.	Address
IC11	4N
IC12	2M
IC13	4M
IC14	2L
IC15	3L

Refer to the schematic diagram for the values of resistors and capacitors.

1
2
3
4
5
6
7

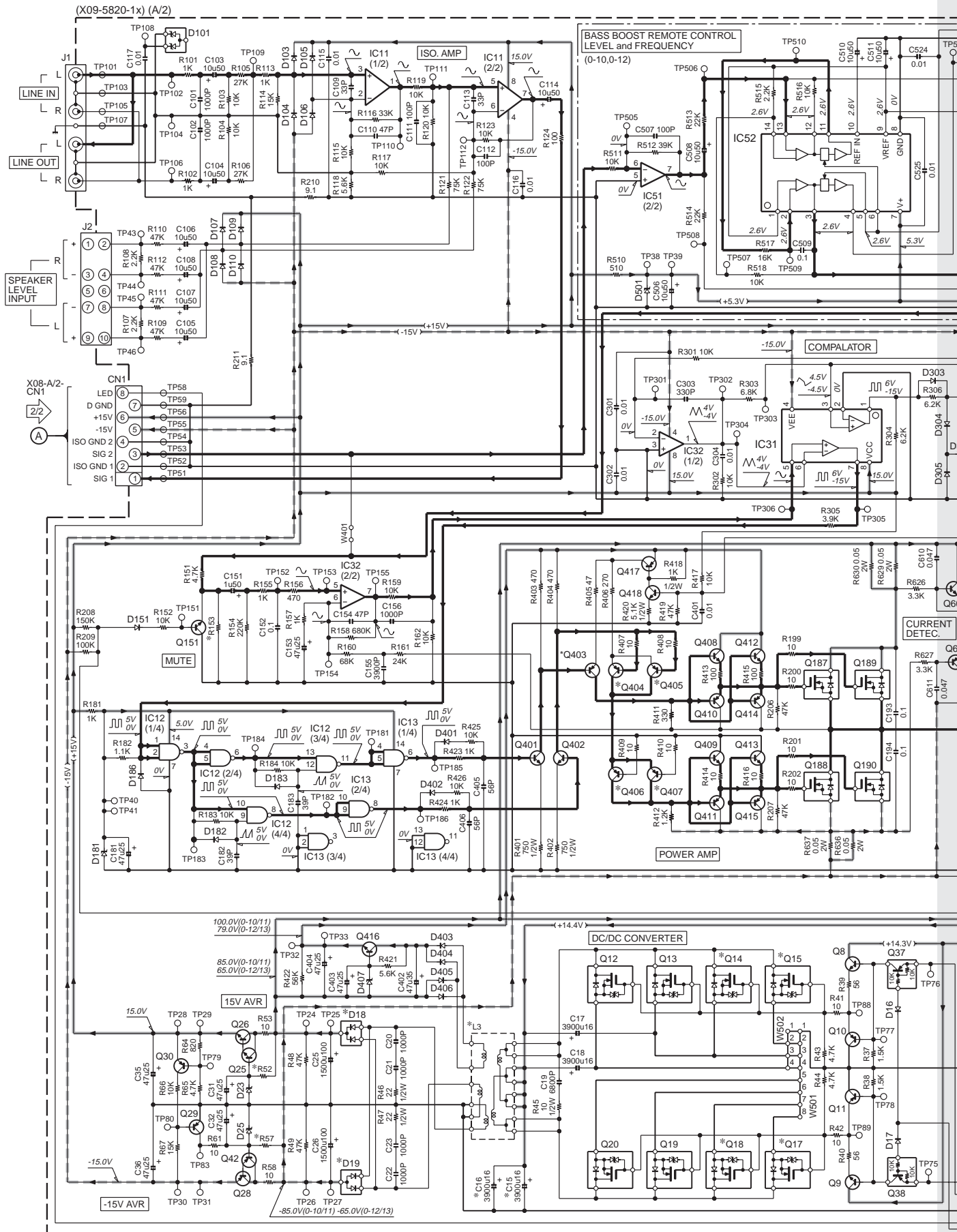

F G H I J
KAC-8102D/8152D
KAC-9102D/9152D

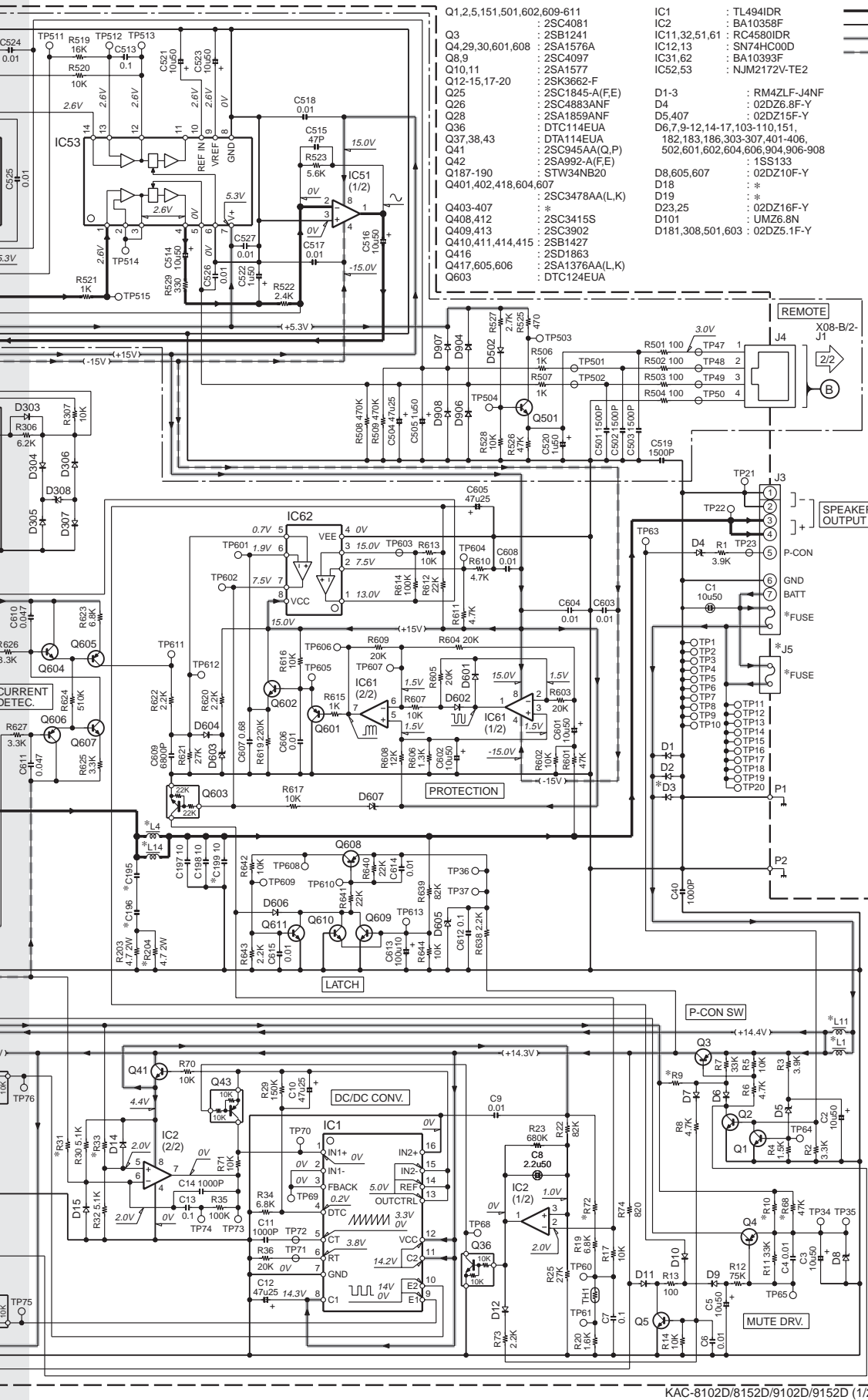

- Q1,2,5,151,501,602,609-611 : 25C4081
 Q3 : 25B1241
 Q4,29,30,601,608 : 25A1576A
 Q5,9 : 25C4097
 Q10,11 : 25A1577
 Q12-15,17-20 : 25K3662-F
 Q25 : 25C1845-A(FE)
 Q26 : 25C4883ANF
 Q28 : 25A1859ANF
 Q36 : DTC114EUA
 Q37,38,43 : DTA114EUA
 Q41 : 25C945AA(Q,P)
 Q42 : 25A992-A(FE)
 Q187-190 : STW34NB20
 Q401,402,418,604,607 : 25C3478AA(L,K)
 Q403-407 : *
 Q408,412 : 25C3415S
 Q409,413 : 25C3902
 Q410,411,414,415 : 25B1427
 Q416 : 25D1863
 Q417,605,606 : 25A1376AA(L,K)
 Q603 : DTC124EUA
- IC1 : TL494IDR
 IC2 : BA10358F
 IC11,32,51,61 : RC4580IDR
 IC12,13 : SN74HC00D
 IC31,62 : BA10393F
 IC52,53 : NJM2172V-TE2
- D1-3 : RM4ZLF-J4NF
 D4 : Q2D26.8F-Y
 D5,407 : Q2DZ15F-Y
 D6,7,9-12,14-17,103-110,151, 182,183,186,303-307,401-406, 502,601,602,604,606,904,906-908 : 1SS133
 D8,605,607 : Q2DZ10F-Y
 D18 : *
 D19 : *
 D23,25 : Q2DZ16F-Y
 D101 : UMZ6.8N
 D181,308,501,603 : Q2DZ5.1F-Y

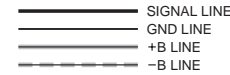

(X09-582x-xx)

MODEL NAME	UNIT No.	C15	C16	C195	C196	D3	D18	D19	FUSE	J5	L3	L11	Q14	Q15	Q18	Q17	Q403	R9	R10	R33	R31	R2	R8	R72	R153
KAC-9152D(K)	0-10	YES	3900P	YES	FRH20A20	30A x 2	YES	FRH20A20	30A x 2	YES	FRH20A20	30A x 2	YES	FRH20A20	30A x 2	YES	FRH20A20	47K	47K	47K	47K	47K	47K	47K	47K
KAC-9152D(M)	0-10	YES	3900P	YES	FCH20A20	FRH20A20	YES	FCH20A20	FRH20A20	YES	FCH20A20	FRH20A20	YES	FCH20A20	FRH20A20	YES	FCH20A20	47K	47K	47K	47K	47K	47K	47K	47K
KAC-9102D(K)	0-11	YES	3900P	YES	FCH20A20	FRH20A20	YES	FCH20A20	FRH20A20	YES	FCH20A20	FRH20A20	YES	FCH20A20	FRH20A20	YES	FCH20A20	47K	47K	47K	47K	47K	47K	47K	47K
KAC-8152D(K)	0-12	—	6800P	—	FCH10A20	FRH10A20	—	FCH10A20	FRH10A20	—	FCH10A20	FRH10A20	—	FCH10A20	FRH10A20	—	FCH10A20	33K	33K	33K	33K	33K	33K	33K	
KAC-8152D(M)	0-12	—	6800P	—	FCH10A20	FRH10A20	—	FCH10A20	FRH10A20	—	FCH10A20	FRH10A20	—	FCH10A20	FRH10A20	—	FCH10A20	33K	33K	33K	33K	33K	33K	33K	
KAC-8102D(K)	0-13	—	6800P	—	FCH10A20	FRH10A20	—	FCH10A20	FRH10A20	—	FCH10A20	FRH10A20	—	FCH10A20	FRH10A20	—	FCH10A20	33K	33K	33K	33K	33K	33K	33K	

CAUTION : For continued safety, replace safety critical components only with manufacturer's recommended parts (refer to parts list).

⚠ Indicates safety critical components. To reduce the risk of electric shock, leakage-current or resistance measurements shall be carried out (exposed parts are acceptably insulated from the supply circuit) before the appliance is returned to the customer.

- DC voltages are as measured with a high impedance voltmeter. Values may vary slightly due to variations between individual instruments or/and units.

KAC-8102D/8152D/9102D/9152D (1/2)

1
2
3
4
5
6
7

1
2
3
4
5
6
7

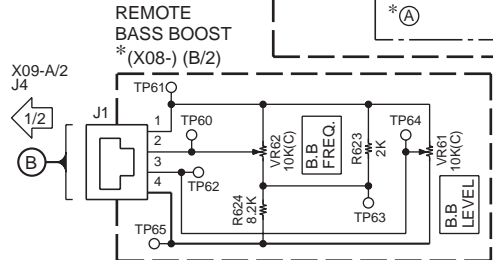
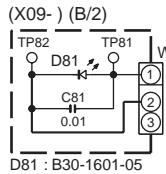
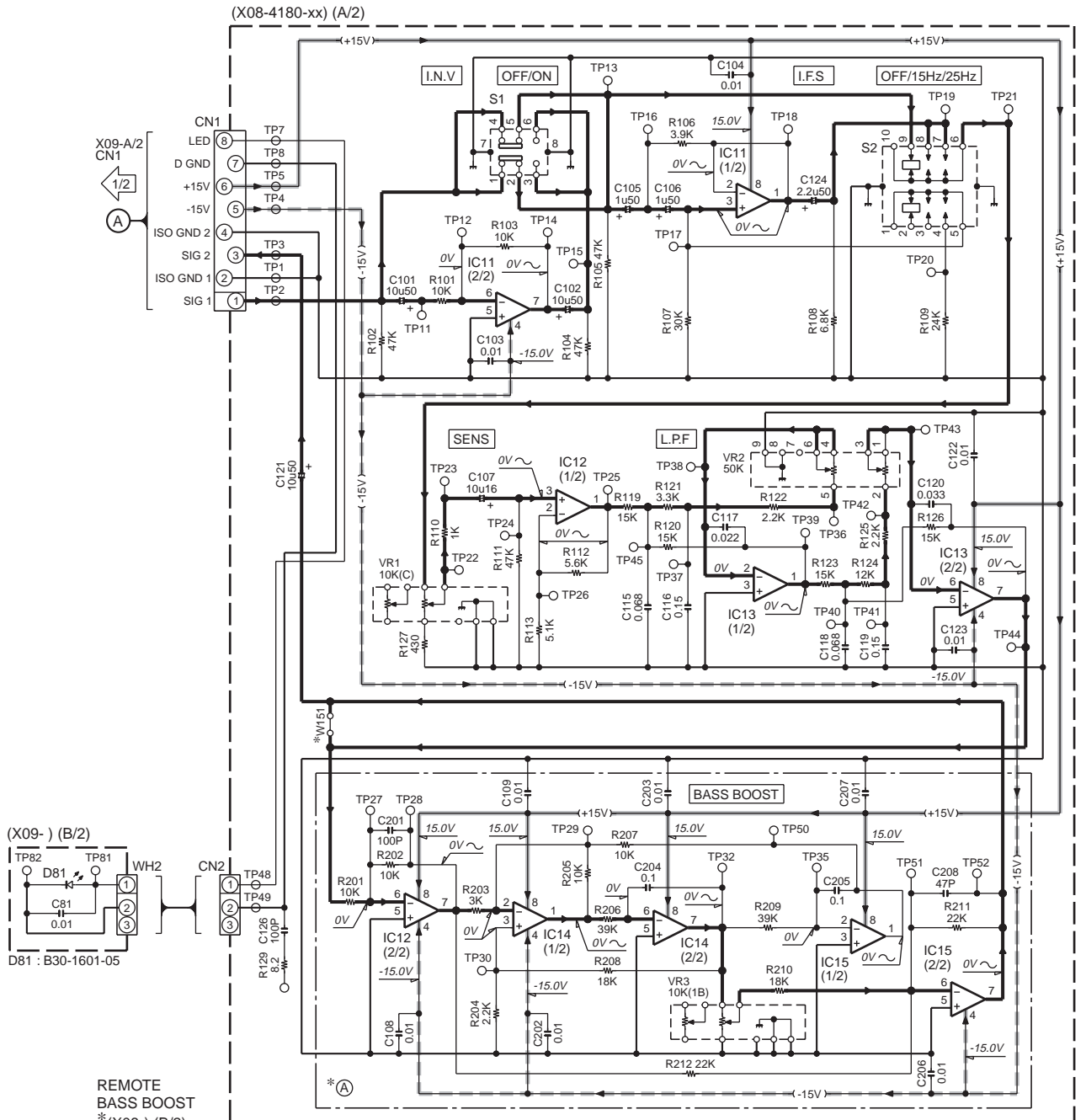

MODEL NAME	UNIT No.	(A)	W151	(X08-)(B/2)
KAC-9152D(K)				
KAC-9152D(M)				
KAC-9152D(E)	0-10	NO	YES	YES
KAC-8152D(K)				
KAC-8152D(M)				
KAC-8152D(E)	0-11	YES	NO	NO

SIGNAL LINE
 GND LINE
 +B LINE
 -B LINE

CAUTION : For continued safety, replace safety critical components only with manufacturer's recommended parts (refer to parts list).
 ⚠ Indicates safety critical components. To reduce the risk of electric shock, leakage-current or resistance measurements shall be carried out (exposed parts are acceptably insulated from the supply circuit) before the appliance is returned to the customer.

- DC voltages are as measured with a high impedance voltmeter. Values may vary slightly due to variations between individual instruments or/and units.

2SA992-A
2SC1845-A

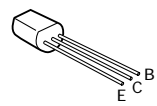

2SA1576A

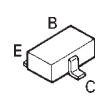

2SC4081

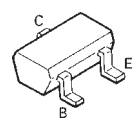

DTA114EUA
DTC114EUA
DTC124EUA

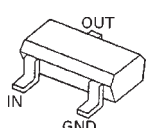

BA10358F

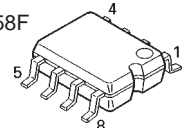

EXPLODED VIEW

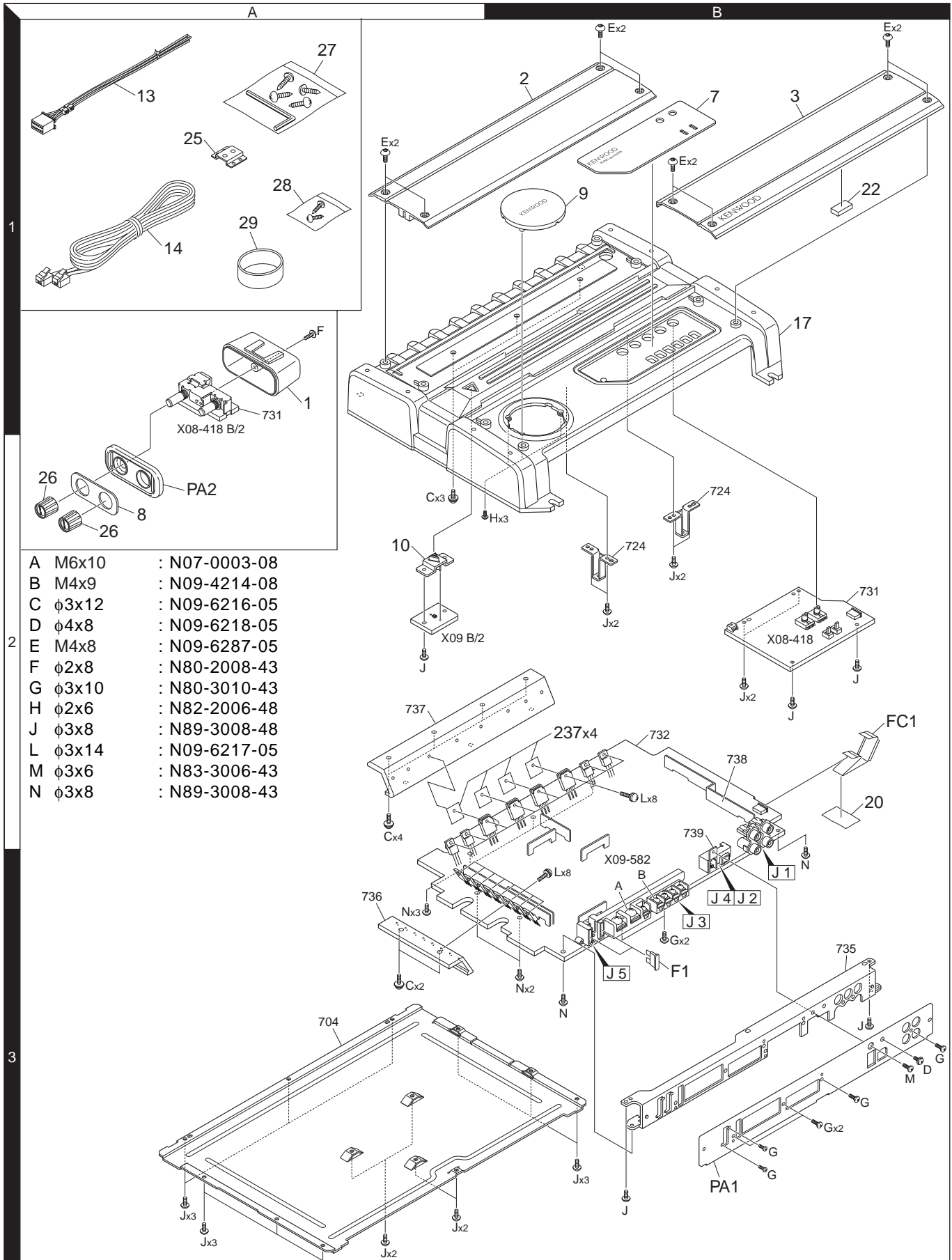

PARTS LIST

* New parts

Parts without **Parts No.** are not supplied.

Les articles non mentionnés dans le **Parts No.** ne sont pas fournis.

Teile ohne **Parts No.** werden nicht geliefert.

Ref. No.	Add	New	Parts No.	Description	Destination
KAC-8102D/8152D/9102D/9152D					
1	1A	*	A02-2738-02	PLASTIC CABINET (REMO)	KE1M1
	1A	*	A02-2738-02	PLASTIC CABINET (REMO)	K2E2M2
2	1B	*	A21-4465-02	DRESSING PANEL	KE1M1
2	1B	*	A21-4465-02	DRESSING PANEL	K2E2M2
2	1B	*	A21-4466-02	DRESSING PANEL	K1K3
3	1B	*	A21-4471-02	DRESSING PANEL	K
3	1B	*	A21-4472-02	DRESSING PANEL	K1
3	1B	*	A21-4473-02	DRESSING PANEL	K2
3	1B	*	A21-4474-02	DRESSING PANEL	K3
3	1B	*	A21-4522-12	DRESSING PANEL	E1M1
3	1B	*	A21-4523-12	DRESSING PANEL	E2M2
PA1	3B	*	A64-3537-02	PANEL	KE1M1
PA1	3B	*	A64-3538-02	PANEL	K2E2M2
PA1	3B	*	A64-3539-02	PANEL	K1
PA1	3B	*	A64-3655-02	PANEL	K3
PA2	2A	*	A64-3541-12	PANEL (REMO)	KE1M1
PA2	2A	*	A64-3541-12	PANEL (REMO)	K2E2M2
7	1B	*	B03-5046-02	DRESSING PLATE	KE1M1
7	1B	*	B03-5047-02	DRESSING PLATE	K1
7	1B	*	B03-5048-02	DRESSING PLATE	K2E2M2
7	1B	*	B03-5060-02	DRESSING PLATE	K3
8	2A	*	B03-5049-04	DRESSING PLATE (REMO)	KE1M1
8	2A	*	B03-5049-04	DRESSING PLATE (REMO)	K2E2M2
9	1B	*	B07-3131-02	ESCUTCHEON	
10	2A	*	B19-2324-03	LIGHTING BOARD	
-		*	B46-0100-50	WARRANTY CARD	
-		*	B58-1427-04	CAUTION CARD	
-		*	B64-3008-00	INSTRUCTI.MANUAL (ENG.FRE.SPA.)	KE1K1
-		*	B64-3008-00	INSTRUCTI.MANUAL (ENG.FRE.SPA.)	K2E2K3
-		*	B64-3009-00	INSTR.MANUAL (GER.DUT.ITA.POR.)	E1E2
-		*	B64-3010-00	INSTRUCTION MANUAL (ENG.T-CHI.)	M1M2
13	1A		E30-6145-05	CONNECTING CORD ASSY	
14	1A		E30-6240-15	MODULAR CABLE	KE1M1
14	1A		E30-6240-15	MODULAR CABLE	K2E2M2
FC1	2B	*	E39-0701-15	FLAT CABLE	
17	1B	*	F01-1778-11	HEAT SINK	
20	2B	*	F09-1958-04	SHEET	
△ F1	3B		F52-0015-05	FUSE (BLADE TYPE) 30A	KE1M1
△ F1	3B		F52-0015-05	FUSE (BLADE TYPE) 30A	K1
△ F1	3B		F52-0016-05	FUSE (BLADE TYPE) 40A	K2E2M2
△ F1	3B		F52-0016-05	FUSE (BLADE TYPE) 40A	K3
22	1B	*	G11-3647-04	CUSHION	
-		*	H10-4932-03	POLYSTYRENE FOAMED FIXTURE	
-		*	H25-1199-04	PROTECTION BAG	
-		*	H25-1200-04	PROTECTION BAG (250X350X0.03)	
-		*	H25-1216-04	PROTECTION BAG	KE1M1
-		*	H25-1216-04	PROTECTION BAG	K2E2M2
-		*	H54-3409-03	ITEM CARTON CASE	K
-		*	H54-3410-03	ITEM CARTON CASE	K1
-		*	H54-3411-03	ITEM CARTON CASE	K2
-		*	H54-3412-03	ITEM CARTON CASE	E1

Ref. No.	Add	New	Parts No.	Description	Destination
-		*	H54-3413-03	ITEM CARTON CASE	E2
-		*	H54-3414-03	ITEM CARTON CASE	M1
-		*	H54-3415-03	ITEM CARTON CASE	M2
-		*	H54-3441-03	ITEM CARTON CASE	K3
25	1A	*	J22-0301-14	MOUNTING HARDWARE	KE1M1
25	1A	*	J22-0301-14	MOUNTING HARDWARE	K2E2M2
26	2A	*	K23-1093-03	KNOB (REMO)	KE1M1
26	2A	*	K23-1093-03	KNOB (REMO)	K2E2M2
27	1A	*	N99-1759-05	SCREW SET	
28	1A	*	N99-1766-05	SCREW SET	KE1M1
28	1A	*	N99-1766-05	SCREW SET	K2E2M2
A	3B		N07-0003-08	SEMS M6 (Au)	
B	3B		N09-4214-08	SEMS M4 (Au)	
C	2B		N09-6216-05	TAPTITE SCREW (3X12)	
D	3B		N09-6218-05	TAPTITE SCREW (4X8)	
E	1B	*	N09-6287-05	DRESSED SCREW (M4X8)	
F	1A		N80-2008-43	PAN HEAD TAPTITE SCREW	KE1M1
F	1A		N80-2008-43	PAN HEAD TAPTITE SCREW	K1K2E2
F	1A		N80-2008-43	PAN HEAD TAPTITE SCREW	M2
G	3B		N80-3010-43	PAN HEAD TAPTITE SCREW	
H	2B		N82-2006-48	BINDING HEAD TAPTITE SCREW	
J	3B		N89-3008-48	BINDING HEAD TAPTITE SCREW	
29	1A		W01-1606-05	ACCESSORIES	
PREAMPLIFIER UNIT (X08-4180-1x)					
C101,102			CD04BJ1H100M	ELECTRO 10UF 50WV	
C103,104			CK73GB1H103K	CHIP C 0.010UF K	
C105,106			CD04BJ1H010M	ELECTRO 1.0UF 50WV	
C107			CD04AS1C100M	ELECTRO 10UF 16WV	
C108,109			CK73GB1H103K	CHIP C 0.010UF K	
C115			CK73GB1H683K	CHIP C 0.068UF K	
C116			CK73FB1E154K	CHIP C 0.15UF K	
C117			CK73GB1H223K	CHIP C 0.022UF K	
C118			CK73GB1H683K	CHIP C 0.068UF K	
C119			CK73FB1E154K	CHIP C 0.15UF K	
C120			CK73GB1C333K	CHIP C 0.033UF K	
C121			CD04BJ1H100M	ELECTRO 10UF 50WV	
C122,123			CK73GB1H103K	CHIP C 0.010UF K	
C124			CD04BJ1H2R2M	ELECTRO 2.2UF 50WV	
C126			CC73GCH1H101J	CHIP C 100PF J	
C201			CC73GCH1H101J	CHIP C 100PF J	K1K3
C202,203			CK73GB1H103K	CHIP C 0.010UF K	K1K3
C204,205			CK73FB1E104K	CHIP C 0.10UF K	K1K3
C206,207			CK73GB1H103K	CHIP C 0.010UF K	K1K3
C208			CC73GCH1H470J	CHIP C 47PF J	K1K3
CN1		*	E41-2447-05	FLAT CABLE CONNECTOR	
CN2		*	E41-0942-05	PIN ASSY	
J1		*	E58-0966-15	RECTANGULAR RECEPTACLE	KE1M1
J1		*	E58-0966-15	RECTANGULAR RECEPTACLE	K2E2M2
R101			RK73GB2A103J	CHIP R 10K J 1/10W	
R102			RK73GB2A473J	CHIP R 47K J 1/10W	
R103			RK73GB2A103J	CHIP R 10K J 1/10W	
R104,105			RK73GB2A473J	CHIP R 47K J 1/10W	
R106			RK73GB2A392J	CHIP R 3.9K J 1/10W	

K : KAC-9152D K1 : KAC-9102D K2 : KAC-8152D K3 : KAC-8102D (North America)
E1 : KAC-9152D E2 : KAC-8152D (Europe) M1 : KAC-9152D M2 : KAC-8152D (Other Areas)

△ Indicates safety critical components.

PARTS LIST

PREAMPLIFIER UNIT (X08-4180-1x)

Ref. No.	A d d	N e w	Parts No.	Description	Desti- nation
R107			RK73GB2A303J	CHIP R 30K J 1/10W	
R108			RK73GB2A682J	CHIP R 6.8K J 1/10W	
R109			RK73GB2A243J	CHIP R 24K J 1/10W	
R110			RK73GB2A102J	CHIP R 1.0K J 1/10W	
R111			RK73GB2A473J	CHIP R 47K J 1/10W	
R112			RK73GB2A562J	CHIP R 5.6K J 1/10W	
R113			RK73GB2A512J	CHIP R 5.1K J 1/10W	
R119,120			RK73GB2A153J	CHIP R 15K J 1/10W	
R121			RK73GB2A332J	CHIP R 3.3K J 1/10W	
R122			RK73GB2A222J	CHIP R 2.2K J 1/10W	
R123			RK73GB2A153J	CHIP R 15K J 1/10W	
R124			RK73GB2A123J	CHIP R 12K J 1/10W	
R125			RK73GB2A222J	CHIP R 2.2K J 1/10W	
R126			RK73GB2A153J	CHIP R 15K J 1/10W	
R127			RK73GB2A431J	CHIP R 430 J 1/10W	
R129			RK73GB2A8R2J	CHIP R 8.2 J 1/10W	
R201,202			RK73GB2A103J	CHIP R 10K J 1/10W	
R203			RK73GB2A302J	CHIP R 3.0K J 1/10W	K1K3
R204			RK73GB2A222J	CHIP R 2.2K J 1/10W	K1K3
R205			RK73GB2A103J	CHIP R 10K J 1/10W	K1K3
R206			RK73GB2A393J	CHIP R 39K J 1/10W	K1K3
R207			RK73GB2A103J	CHIP R 10K J 1/10W	K1K3
R208			RK73GB2A183J	CHIP R 18K J 1/10W	K1K3
R209			RK73GB2A393J	CHIP R 39K J 1/10W	K1K3
R210			RK73GB2A183J	CHIP R 18K J 1/10W	K1K3
R211,212			RK73GB2A223J	CHIP R 22K J 1/10W	K1K3
R623			RK73GB2A202J	CHIP R 2.0K J 1/10W	KE1M1
R623			RK73GB2A202J	CHIP R 2.0K J 1/10W	K2E2M2
R624			RK73GB2A822J	CHIP R 8.2K J 1/10W	KE1M1
R624			RK73GB2A822J	CHIP R 8.2K J 1/10W	K2E2M2
VR1			R31-0238-05	VARIABLE RESISTOR	
VR2			R31-0241-05	VARIABLE RESISTOR	
VR3			R31-0244-05	VARIABLE RESISTOR	K1K3
VR61,62		*	R31-0243-05	VARIABLE RESISTOR	KE1M1
VR61,62		*	R31-0243-05	VARIABLE RESISTOR	K2E2M2
W51			R92-1252-05	CHIP R 0 OHM J 1/16W	
W52			R92-2053-05	CHIP R 0 OHM J 1/8W	
W151			R92-1252-05	CHIP R 0 OHM J 1/16W	KE1M1
W151			R92-1252-05	CHIP R 0 OHM J 1/16W	K2E2M2
W251-253			R92-1252-05	CHIP R 0 OHM J 1/16W	K1K3
W254-256			R92-2053-05	CHIP R 0 OHM J 1/8W	K1K3
S1			S62-0873-05	SLIDE SWITCH	
S2			S62-0874-05	SLIDE SWITCH	
IC11-13			RC4580IDR	ANALOGUE IC	KE1M1
IC11-13			RC4580IDR	ANALOGUE IC	K2E2M2
IC11-15			RC4580IDR	ANALOGUE IC	K1K3
AUDIO UNIT (X09-5820-1x)					
D81			B30-1601-05	LED	
C1			C90-5557-05	ELECTRO 10UF 25WV	
C2,3			CD04BJ1H100M	ELECTRO 10UF 50WV	
C4			CK73GB1H103K	CHIP C 0.010UF K	
C5			CD04BJ1H100M	ELECTRO 10UF 50WV	
C6			CK73GB1H103K	CHIP C 0.010UF K	

Ref. No.	A d d	N e w	Parts No.	Description	Desti- nation
C7			CK73GB1H104K	CHIP C 0.10UF K	
C8		*	C90-5563-05	ELECTRO 2.2UF 50WV	
C9			CK73GB1H103K	CHIP C 0.010UF K	
C10			CD04BJ1E470M	ELECTRO 47UF 25WV	
C11			CK73GB1H102K	CHIP C 1000PF K	
C12			CD04BJ1E470M	ELECTRO 47UF 25WV	
C13			CK73FB1E104K	CHIP C 0.10UF K	
C14			CK73GB1H102K	CHIP C 1000PF K	
C15-18			CD04BC1C392M	ELECTRO 3900UF 16WV	KE1M1
C15-18			CD04BC1C392M	ELECTRO 3900UF 16WV	K1
C17,18			CD04BC1C392M	ELECTRO 3900UF 16WV	K2E2M2
C17,18			CD04BC1C392M	ELECTRO 3900UF 16WV	K3
C19			CQ92FM1H682J	MYLAR 6800PF J	
C20-23			CQ92FM1H102J	MYLAR 1000PF J	
C25,26			C90-5688-05	ELECTRO 1500UF 100WV	
C31,32			CD04BJ1E470M	ELECTRO 47UF 25WV	
C35,36			CD04BJ1E470M	ELECTRO 47UF 25WV	
C40			CQ92FM1H102J	MYLAR 1000PF J	
C81			CK73GB1H103K	CHIP C 0.010UF K	
C101,102			CK73GB1H102K	CHIP C 1000PF K	
C103-108			CD04BJ1H100M	ELECTRO 10UF 50WV	
C109			CC73GCH1H330J	CHIP C 33PF J	
C110			CC73GCH1H470J	CHIP C 47PF J	
C111,112			CC73GCH1H101J	CHIP C 100PF J	
C113			CC73GCH1H330J	CHIP C 33PF J	
C114			CD04BJ1H100M	ELECTRO 10UF 50WV	
C115-117			CK73GB1H103K	CHIP C 0.010UF K	
C151			CD04BJ1H010M	ELECTRO 1.0UF 50WV	
C152			CK73GB1H104K	CHIP C 0.10UF K	
C153			CD04BJ1E470M	ELECTRO 47UF 25WV	
C154			CC73GCH1H470J	CHIP C 47PF J	
C155			CQ92FM1H392J	MYLAR 3900PF J	
C156			CK73GB1H102K	CHIP C 1000PF K	
C181			CD04BJ1E470M	ELECTRO 47UF 25WV	
C182,183			CC73GCH1H390J	CHIP C 39PF J	
C193,194			CF92FV2A104J	MF-C 0.10UF J	
C195,196			CQ92FM1H392J	MYLAR 3900PF J	KE1M1
C195,196			CQ92FM1H392J	MYLAR 3900PF J	K1
C195,196			CQ92FM1H682J	MYLAR 6800PF J	K2E2M2
C195,196			CQ92FM1H682J	MYLAR 6800PF J	K3
C197-199			C91-2267-05	MF-C 10UF J	KE1M1
C197-199			C91-2267-05	MF-C 10UF J	K1
C197,198			C91-2267-05	MF-C 10UF J	K2E2M2
C197,198			C91-2267-05	MF-C 10UF J	K3
C301,302			CK73GB1H103K	CHIP C 0.010UF K	
C303			CC73GCH1H331J	CHIP C 330PF J	
C304			CK73GB1H103K	CHIP C 0.010UF K	
C401			CK73GB1H103K	CHIP C 0.010UF K	
C402		*	CD04BJ1V470M	ELECTRO 47UF 35WV	
C403,404			CD04BJ1E470M	ELECTRO 47UF 25WV	
C405,406			CC73GCH1H560J	CHIP C 56PF J	
C501-503			CK73GB1H152K	CHIP C 1500PF K	KE1M1
C501-503			CK73GB1H152K	CHIP C 1500PF K	K2E2M2
C504			CD04BJ1E470M	ELECTRO 47UF 25WV	KE1M1
C504			CD04BJ1E470M	ELECTRO 47UF 25WV	K2E2M2

K : KAC-9152D K1 : KAC-9102D K2 : KAC-8152D K3 : KAC-8102D (North America)
E1 : KAC-9152D E2 : KAC-8152D (Europe) M1 : KAC-9152D M2 : KAC-8152D (Other Areas)

△ Indicates safety critical components.

PARTS LIST

AUDIO UNIT (X09-5820-1x)

Ref. No.	Add	New	Parts No.	Description	Destination	Ref. No.	Add	New	Parts No.	Description	Destination
C505			CD04BJ1H010M	ELECTRO 1.0UF 50WV	KE1M1	WH2		*	E39-0710-05	WIRING HARNESS	
C505			CD04BJ1H010M	ELECTRO 1.0UF 50WV	K2E2M2						
C506			CD04BJ1H100M	ELECTRO 10UF 50WV	KE1M1	237	2B		F20-2205-14	INSULATING SHEET	
C506			CD04BJ1H100M	ELECTRO 10UF 50WV	K2E2M2						
C507			CC73GCH1H101J	CHIP C 100PF J	KE1M1	J5			J13-0602-05	FUSE HOLDER	KE1M1
C507			CC73GCH1H101J	CHIP C 100PF J	K2E2M2	J5			J13-0602-05	FUSE HOLDER	K1
C508			CD04BJ1H100M	ELECTRO 10UF 50WV	KE1M1	L1		*	L33-2256-05	CHOKO COIL	KE1M1
C508			CD04BJ1H100M	ELECTRO 10UF 50WV	K2E2M2	L1		*	L33-2256-05	CHOKO COIL	K1
C509			CK73GB1C104K	CHIP C 0.10UF K	KE1M1	L3		*	L19-0778-05	TRANSFORMER FOR CONVERTER	KE1M1
C509			CK73GB1C104K	CHIP C 0.10UF K	K2E2M2	L3		*	L19-0778-05	TRANSFORMER FOR CONVERTER	K1
C510,511			CD04BJ1H100M	ELECTRO 10UF 50WV	KE1M1	L3		*	L19-0779-05	TRANSFORMER FOR CONVERTER	K2E2M2
C510,511			CD04BJ1H100M	ELECTRO 10UF 50WV	K2E2M2	L3		*	L19-0779-05	TRANSFORMER FOR CONVERTER	K3
C513			CK73GB1C104K	CHIP C 0.10UF K	KE1M1	L4		*	L33-2257-05	CHOKO COIL	KE1M1
C513			CK73GB1C104K	CHIP C 0.10UF K	K2E2M2	L4		*	L33-2257-05	CHOKO COIL	K1
C514			CD04BJ1H100M	ELECTRO 10UF 50WV	KE1M1	L11		*	L33-1818-05	CHOKO COIL	K2E2M2
C514			CD04BJ1H100M	ELECTRO 10UF 50WV	K2E2M2	L11		*	L33-1818-05	CHOKO COIL	K3
C514			CD04BJ1H100M	ELECTRO 10UF 50WV	K2E2M2	L14		*	L33-2259-05	CHOKO COIL	K2E2M2
C515			CC73GCH1H470J	CHIP C 47PF J	KE1M1	L14		*	L33-2259-05	CHOKO COIL	K3
C515			CC73GCH1H470J	CHIP C 47PF J	K2E2M2						
C516			CD04BJ1H100M	ELECTRO 10UF 50WV	KE1M1	G	3B		N80-3010-43	PAN HEAD TAPTITE SCREW	
C516			CD04BJ1H100M	ELECTRO 10UF 50WV	K2E2M2	L	2B		N09-6217-05	TAPTITE SCREW	
C517,518			CK73GB1H103K	CHIP C 0.010UF K	KE1M1	M	3B	*	N83-3006-43	PAN HEAD TAPTITE SCREW	
C517,518			CK73GB1H103K	CHIP C 0.010UF K	K2E2M2	N	2B	*	N89-3008-43	BINDING HEAD TAPTITE SCREW	
C519			CK73GB1H152K	CHIP C 1500PF K	KE1M1	R1			RD14BB2C392J	RD 3.9K J 1/6W	
C519			CK73GB1H152K	CHIP C 1500PF K	K2E2M2	R2			RK73GB2A332J	CHIP R 3.3K J 1/10W	
C519			CK73GB1H152K	CHIP C 1500PF K	KE1M1	R3			RK73GB2A392J	CHIP R 3.9K J 1/10W	
C520			CD04BJ1H010M	ELECTRO 1.0UF 50WV	KE1M1	R4			RK73GB2A152J	CHIP R 1.5K J 1/10W	
C520			CD04BJ1H010M	ELECTRO 1.0UF 50WV	K2E2M2	R5			RK73GB2A103J	CHIP R 10K J 1/10W	
C521			CD04BJ1H100M	ELECTRO 10UF 50WV	KE1M1	R6			RK73GB2A472J	CHIP R 4.7K J 1/10W	
C521			CD04BJ1H100M	ELECTRO 10UF 50WV	K2E2M2	R7			RK73GB2A333J	CHIP R 33K J 1/10W	
C522			CD04BJ1H010M	ELECTRO 1.0UF 50WV	KE1M1	R8			RK73GB2A472J	CHIP R 4.7K J 1/10W	
C522			CD04BJ1H010M	ELECTRO 1.0UF 50WV	K2E2M2	R9			RK73EB2E333J	CHIP R 33K J 1/4W	K2E2M2
C523			CD04BJ1H100M	ELECTRO 10UF 50WV	KE1M1	R9			RK73EB2E333J	CHIP R 33K J 1/4W	K3
C523			CD04BJ1H100M	ELECTRO 10UF 50WV	K2E2M2	R9			RK73EB2E513J	CHIP R 51K J 1/4W	KE1M1
C524-527			CK73GB1H103K	CHIP C 0.010UF K	KE1M1	R9			RK73EB2E513J	CHIP R 51K J 1/4W	K1
C524-527			CK73GB1H103K	CHIP C 0.010UF K	K2E2M2	R10			RK73EB2E153J	CHIP R 15K J 1/4W	K2E2M2
C601,602			CD04BJ1H100M	ELECTRO 10UF 50WV	KE1M1	R10			RK73EB2E153J	CHIP R 15K J 1/4W	K3
C603,604			CK73GB1H103K	CHIP C 0.010UF K	KE1M1	R10			RK73EB2E473J	CHIP R 47K J 1/4W	KE1M1
C605			CD04BJ1E470M	ELECTRO 47UF 25WV	KE1M1	R10			RK73EB2E473J	CHIP R 47K J 1/4W	K1
C606			CK73GB1H103K	CHIP C 0.010UF K	KE1M1	R11			RK73GB2A333J	CHIP R 33K J 1/10W	
C607			CK73FB1C684K	CHIP C 0.68UF K	KE1M1	R12			RK73GB2A753J	CHIP R 75K J 1/10W	
C608			CK73GB1H103K	CHIP C 0.010UF K	KE1M1	R13			RK73GB2A101J	CHIP R 100 J 1/10W	
C609			CK73GB1H682K	CHIP C 6800PF K	KE1M1	R14			RK73GB2A103J	CHIP R 10K J 1/10W	
C610,611			CK73GB1E473K	CHIP C 0.047UF K	KE1M1	R17			RK73GB2A682J	CHIP R 6.8K J 1/10W	
C612			CK73FB1E104K	CHIP C 0.10UF K	K2E2M2	R20			RK73GB2A162J	CHIP R 1.6K J 1/10W	
C613			CD04BJ1A101M	ELECTRO 100UF 10WV	K1K3	R22			RK73GB2A823J	CHIP R 82K J 1/10W	
C614,615			CK73GB1H103K	CHIP C 0.010UF K	KE1M1	R23			RK73GB2A684J	CHIP R 680K J 1/10W	
CN1		*	E41-2447-05	FLAT CABLE CONNECTOR	KE1M1	R25			RK73GB2A273J	CHIP R 27K J 1/10W	
J1		*	E63-0921-05	PIN JACK	K2E2M2	R29			RK73GB2A154J	CHIP R 150K J 1/10W	
J1		*	E63-0921-05	PIN JACK	K1K3	R30			RK73GB2A512J	CHIP R 5.1K J 1/10W	
J1		*	E63-0926-05	PIN JACK	KE1M1	R31			RK73GB2A224J	CHIP R 220K J 1/10W	
J2		*	E58-1031-05	RECTANGULAR RECEPTACLE	K2E2M2	R32			RK73GB2A512J	CHIP R 5.1K J 1/10W	
J3		*	E70-0838-05	SCREW TERMINAL BOARD	KE1M1	R33			RK73GB2A224J	CHIP R 220K J 1/10W	
J3		*	E70-0838-05	SCREW TERMINAL BOARD	K2E2M2	R34			RK73GB2A682J	CHIP R 6.8K J 1/10W	
J3		*	E70-0843-05	SCREW TERMINAL BOARD	K1K3						
J4		*	E58-0966-15	RECTANGULAR RECEPTACLE	KE1M1						
J4		*	E58-0966-15	RECTANGULAR RECEPTACLE	K2E2M2						

K : KAC-9152D K1 : KAC-9102D K2 : KAC-8152D K3 : KAC-8102D (North America)
E1 : KAC-9152D E2 : KAC-8152D (Europe) M1 : KAC-9152D M2 : KAC-8152D (Other Areas)

△ Indicates safety critical components.

PARTS LIST

AUDIO UNIT (X09-5820-1x)

Ref. No.	A	N	Parts No.	Description	Desti- nation	Ref. No.	A	N	Parts No.	Description	Desti- nation
	d	e					d	e			
R35			RK73GB2A104J	CHIP R 100K J 1/10W		R155			RK73GB2A102J	CHIP R 1.0K J 1/10W	
R36			RK73GB2A203J	CHIP R 20K J 1/10W		R156			RK73GB2A471J	CHIP R 470 J 1/10W	
R37,38			RK73GB2A152J	CHIP R 1.5K J 1/10W		R157			RK73GB2A102J	CHIP R 1.0K J 1/10W	
R39,40			RK73GB2A560J	CHIP R 56 J 1/10W		R158			RK73GB2A684J	CHIP R 680K J 1/10W	
R41,42			RK73GB2A100J	CHIP R 10 J 1/10W		R159			RK73GB2A103J	CHIP R 10K J 1/10W	
R43,44			RK73GB2A472J	CHIP R 4.7K J 1/10W		R160			RK73GB2A683J	CHIP R 68K J 1/10W	
R45			RD14DB2H100J	SMALL-RD 10 J 1/2W		R161			RD14BB2E243J	RD 24K J 1/4W	
R46,47			RD14DB2H220J	SMALL-RD 22 J 1/2W		R162			RK73GB2A103J	CHIP R 10K J 1/10W	
R48,49			RK73EB2E473J	CHIP R 47K J 1/4W		R181			RK73EB2E102J	CHIP R 1.0K J 1/4W	
R52			RD14BB2C333J	RD 33K J 1/6W	K2E2M2	R182			RK73GB2A112J	CHIP R 1.1K J 1/10W	
R52			RD14BB2C333J	RD 33K J 1/6W	K3	R183,184			RK73GB2A103J	CHIP R 10K J 1/10W	
R52			RD14BB2C473J	RD 47K J 1/6W	KE1M1	R199-202			RK73EB2E100J	CHIP R 10 J 1/4W	
R52			RD14BB2C473J	RD 47K J 1/6W	K1	R203	*		RS14KB3D4R7JP	FL-PROOF RS 4.7 J 2W	K2E2M2
R53			RK73EB2E100J	CHIP R 10 J 1/4W		R203	*		RS14KB3D4R7JP	FL-PROOF RS 4.7 J 2W	K3
R57			RD14BB2C333J	RD 33K J 1/6W	K2E2M2	R203,204	*		RS14KB3D4R7JP	FL-PROOF RS 4.7 J 2W	KE1M1
R57			RD14BB2C333J	RD 33K J 1/6W	K3	R203,204	*		RS14KB3D4R7JP	FL-PROOF RS 4.7 J 2W	K1
R57			RD14BB2C473J	RD 47K J 1/6W	KE1M1	R206,207			RK73GB2A473J	CHIP R 47K J 1/10W	
R57			RD14BB2C473J	RD 47K J 1/6W	K1	R208			RK73GB2A154J	CHIP R 150K J 1/10W	
R58			RK73EB2E100J	CHIP R 10 J 1/4W		R209			RK73GB2A104J	CHIP R 100K J 1/10W	
R61			RK73GB2A100J	CHIP R 10 J 1/10W		R210,211			RK73GB2A9R1J	CHIP R 9.1 J 1/10W	
R64			RK73GB2A821J	CHIP R 820 J 1/10W		R301,302			RK73GB2A103J	CHIP R 10K J 1/10W	
R65			RK73GB2A472J	CHIP R 4.7K J 1/10W		R303			RK73GB2A682J	CHIP R 6.8K J 1/10W	
R66			RK73GB2A103J	CHIP R 10K J 1/10W		R304			RK73GB2A622J	CHIP R 6.2K J 1/10W	
R67			RK73GB2A153J	CHIP R 15K J 1/10W		R305			RK73GB2A392J	CHIP R 3.9K J 1/10W	
R68			RK73EB2E473J	CHIP R 47K J 1/4W	KE1M1	R306			RK73GB2A622J	CHIP R 6.2K J 1/10W	
R68			RK73EB2E473J	CHIP R 47K J 1/4W	K1	R307			RK73GB2A103J	CHIP R 10K J 1/10W	
R70,71			RK73GB2A103J	CHIP R 10K J 1/10W		R401,402			RD14DB2H751J	SMALL-RD 750 J 1/2W	
R72			RK73GB2A331J	CHIP R 330 J 1/10W	KE1M1	R403,404			RK73EB2E471J	CHIP R 470 J 1/4W	
R72			RK73GB2A331J	CHIP R 330 J 1/10W	K1	R405			RK73EB2E470J	CHIP R 47 J 1/4W	
R72			RK73GB2A621J	CHIP R 620 J 1/10W	K2E2M2	R406			RK73EB2E271J	CHIP R 270 J 1/4W	
R72			RK73GB2A621J	CHIP R 620 J 1/10W	K3	R407-410			RK73EB2E100J	CHIP R 10 J 1/4W	
R73			RK73GB2A222J	CHIP R 2.2K J 1/10W		R411			RK73EB2E331J	CHIP R 330 J 1/4W	
R74			RK73EB2E821J	CHIP R 820 J 1/4W		R412			RK73EB2E122J	CHIP R 1.2K J 1/4W	
R101,102			RD14BB2C102J	RD 1.0K J 1/6W		R413			RK73EB2E101J	CHIP R 100 J 1/4W	
R103,104			RK73GB2A103J	CHIP R 10K J 1/10W		R414			RK73EB2E100J	CHIP R 10 J 1/4W	
R105,106			RK73GB2A273J	CHIP R 27K J 1/10W		R415			RK73EB2E101J	CHIP R 100 J 1/4W	
R107,108			RD14BB2C222J	RD 2.2K J 1/6W		R416			RK73EB2E100J	CHIP R 10 J 1/4W	
R109-112			RD14BB2C473J	RD 47K J 1/6W		R417			RK73GB2A103J	CHIP R 10K J 1/10W	
R113			RK73GB2A102J	CHIP R 1.0K J 1/10W		R418			RD14DB2H102J	SMALL-RD 1.0K J 1/2W	
R114			RK73GB2A153J	CHIP R 15K J 1/10W		R419			RK73GB2A473J	CHIP R 47K J 1/10W	
R115			RK73GB2A103J	CHIP R 10K J 1/10W		R420			RD14DB2H512J	SMALL-RD 5.1K J 1/2W	
R116			RK73GB2A333J	CHIP R 33K J 1/10W		R421			RK73GB2A562J	CHIP R 5.6K J 1/10W	
R117			RN73GH1J103D	CHIP R 10K D 1/16W		R422			RD14BB2C563J	RD 56K J 1/6W	
R118			RD14BB2C562J	RD 5.6K J 1/6W		R423,424			RK73GB2A102J	CHIP R 1.0K J 1/10W	
R119,120			RN73GH1J103D	CHIP R 10K D 1/16W		R425,426			RK73GB2A103J	CHIP R 10K J 1/10W	
R121,122			RK73GB2A753J	CHIP R 75K J 1/10W		R501-504			RD14BB2C101J	RD 100 J 1/6W	KE1M1
R123			RN73GH1J103D	CHIP R 10K D 1/16W		R501-504			RD14BB2C101J	RD 100 J 1/6W	K2E2M2
R124			RK73GB2A101J	CHIP R 100 J 1/10W		R506,507			RK73GB2A102J	CHIP R 1.0K J 1/10W	KE1M1
R151			RK73GB2A472J	CHIP R 4.7K J 1/10W		R506,507			RK73GB2A102J	CHIP R 1.0K J 1/10W	K2E2M2
R152			RK73GB2A103J	CHIP R 10K J 1/10W		R508,509			RK73GB2A474J	CHIP R 470K J 1/10W	KE1M1
R153			RK73GB2A153J	CHIP R 15K J 1/10W	KE1M1	R508,509			RK73GB2A474J	CHIP R 470K J 1/10W	K2E2M2
R153			RK73GB2A153J	CHIP R 15K J 1/10W	K1	R510			RD14BB2E511J	RD 510 J 1/4W	KE1M1
R153			RK73GB2A682J	CHIP R 6.8K J 1/10W	K2E2M2	R510			RD14BB2E511J	RD 510 J 1/4W	K2E2M2
R153			RK73GB2A682J	CHIP R 6.8K J 1/10W	K3	R511			RK73GB2A103J	CHIP R 10K J 1/10W	KE1M1
R154			RK73GB2A224J	CHIP R 220K J 1/10W		R511			RK73GB2A103J	CHIP R 10K J 1/10W	K2E2M2

K : KAC-9152D K1 : KAC-9102D K2 : KAC-8152D K3 : KAC-8102D (North America)
E1 : KAC-9152D E2 : KAC-8152D (Europe) M1 : KAC-9152D M2 : KAC-8152D (Other Areas)

△ Indicates safety critical components.

PARTS LIST

AUDIO UNIT (X09-5820-1x)

Ref. No.	Add	New	Parts No.	Description	Destination	Ref. No.	Add	New	Parts No.	Description	Destination
R512			RK73GB2A393J	CHIP R 39K J 1/10W	KE1M1	R639			RK73GB2A823J	CHIP R 82K J 1/10W	
R512			RK73GB2A393J	CHIP R 39K J 1/10W	K2E2M2	R640,641			RK73GB2A223J	CHIP R 22K J 1/10W	
R513,514			RK73GB2A223J	CHIP R 22K J 1/10W	KE1M1	R642			RK73GB2A103J	CHIP R 10K J 1/10W	
R513,514			RK73GB2A223J	CHIP R 22K J 1/10W	K2E2M2	R643			RK73GB2A222J	CHIP R 2.2K J 1/10W	
R515			RK73GB2A222J	CHIP R 2.2K J 1/10W	KE1M1	R644			RK73GB2A103J	CHIP R 10K J 1/10W	
R515			RK73GB2A222J	CHIP R 2.2K J 1/10W	K2E2M2	W301,302			R92-2053-05	CHIP R 0 OHM J 1/8W	
R516			RK73GB2A103J	CHIP R 10K J 1/10W	KE1M1	W303-309			R92-1252-05	CHIP R 0 OHM J 1/16W	
R516			RK73GB2A103J	CHIP R 10K J 1/10W	K2E2M2	W317,318			R92-1252-05	CHIP R 0 OHM J 1/16W	
R517			RK73GB2A163J	CHIP R 16K J 1/10W	KE1M1	W319			R92-2053-05	CHIP R 0 OHM J 1/8W	
R517			RK73GB2A163J	CHIP R 16K J 1/10W	K2E2M2	W320-323			R92-1252-05	CHIP R 0 OHM J 1/16W	
R518			RK73GB2A103J	CHIP R 10K J 1/10W	KE1M1	W324			R92-2053-05	CHIP R 0 OHM J 1/8W	KE1M1
R518			RK73GB2A103J	CHIP R 10K J 1/10W	K2E2M2	W324			R92-2053-05	CHIP R 0 OHM J 1/8W	K2E2M2
R519			RK73GB2A163J	CHIP R 16K J 1/10W	KE1M1	W326			R92-2053-05	CHIP R 0 OHM J 1/8W	
R519			RK73GB2A163J	CHIP R 16K J 1/10W	K2E2M2	W328			R92-2053-05	CHIP R 0 OHM J 1/8W	KE1M1
R520			RK73GB2A103J	CHIP R 10K J 1/10W	KE1M1	W328			R92-2053-05	CHIP R 0 OHM J 1/8W	K2E2M2
R520			RK73GB2A103J	CHIP R 10K J 1/10W	K2E2M2	W329			R92-1252-05	CHIP R 0 OHM J 1/16W	
R521			RK73GB2A102J	CHIP R 1.0K J 1/10W	KE1M1	W330,331			R92-2053-05	CHIP R 0 OHM J 1/8W	
R521			RK73GB2A102J	CHIP R 1.0K J 1/10W	K2E2M2	W332			R92-1252-05	CHIP R 0 OHM J 1/16W	KE1M1
R522			RK73GB2A242J	CHIP R 2.4K J 1/10W	KE1M1	W332			R92-1252-05	CHIP R 0 OHM J 1/16W	K2E2M2
R522			RK73GB2A242J	CHIP R 2.4K J 1/10W	K2E2M2	W333			R92-2053-05	CHIP R 0 OHM J 1/8W	KE1M1
R523			RK73GB2A562J	CHIP R 5.6K J 1/10W	KE1M1	W333			R92-2053-05	CHIP R 0 OHM J 1/8W	K2E2M2
R523			RK73GB2A562J	CHIP R 5.6K J 1/10W	K2E2M2	W336,337			R92-1252-05	CHIP R 0 OHM J 1/16W	KE1M1
R525			RK73GB2A471J	CHIP R 470 J 1/10W	KE1M1	W336,337			R92-1252-05	CHIP R 0 OHM J 1/16W	K2E2M2
R525			RK73GB2A471J	CHIP R 470 J 1/10W	K2E2M2	W337			R92-1252-05	CHIP R 0 OHM J 1/16W	K1K3
R526			RK73GB2A473J	CHIP R 47K J 1/10W	KE1M1	W338			R92-2053-05	CHIP R 0 OHM J 1/8W	
R526			RK73GB2A473J	CHIP R 47K J 1/10W	K2E2M2	W339			R92-1252-05	CHIP R 0 OHM J 1/16W	
R527			RK73GB2A272J	CHIP R 2.7K J 1/10W	KE1M1	W346			R92-1252-05	CHIP R 0 OHM J 1/16W	
R527			RK73GB2A272J	CHIP R 2.7K J 1/10W	K2E2M2	W348			R92-2053-05	CHIP R 0 OHM J 1/8W	
R528			RK73GB2A103J	CHIP R 10K J 1/10W	KE1M1	W350			R92-2053-05	CHIP R 0 OHM J 1/8W	KE1M1
R528			RK73GB2A103J	CHIP R 10K J 1/10W	K2E2M2	W350			R92-2053-05	CHIP R 0 OHM J 1/8W	K2E2M2
R529			RK73GB2A331J	CHIP R 330 J 1/10W	KE1M1	W351-357			R92-1252-05	CHIP R 0 OHM J 1/16W	
R529			RK73GB2A331J	CHIP R 330 J 1/10W	K2E2M2	W358			R92-2053-05	CHIP R 0 OHM J 1/8W	
R601			RK73GB2A473J	CHIP R 47K J 1/10W		W360,361			R92-1252-05	CHIP R 0 OHM J 1/16W	KE1M1
R602			RK73GB2A103J	CHIP R 10K J 1/10W		W360,361			R92-1252-05	CHIP R 0 OHM J 1/16W	K2E2M2
R603-605			RK73GB2A203J	CHIP R 20K J 1/10W		W361			R92-1252-05	CHIP R 0 OHM J 1/16W	K1K3
R606			RK73GB2A132J	CHIP R 1.3K J 1/10W		W401			R92-1252-05	CHIP R 0 OHM J 1/16W	K1K3
R607			RK73GB2A103J	CHIP R 10K J 1/10W		D1-3	*		RM4ZLF-J4NF	DIODE	KE1M1
R608			RK73GB2A123J	CHIP R 12K J 1/10W		D1-3	*		RM4ZLF-J4NF	DIODE	K1
R609			RK73GB2A203J	CHIP R 20K J 1/10W		D1,2	*		RM4ZLF-J4NF	DIODE	K2E2M2
R610,611			RK73GB2A472J	CHIP R 4.7K J 1/10W		D1,2	*		RM4ZLF-J4NF	DIODE	K3
R612			RK73GB2A223J	CHIP R 22K J 1/10W		D4			02DZ6.8F-Y	ZENER DIODE	
R613			RK73GB2A103J	CHIP R 10K J 1/10W		D5	*		02DZ15F-Y	ZENER DIODE	
R614			RK73GB2A104J	CHIP R 100K J 1/10W		D6,7			1SS133	DIODE	
R615			RK73GB2A102J	CHIP R 1.0K J 1/10W		D8	*		02DZ10F-Y	ZENER DIODE	
R616,617			RK73GB2A103J	CHIP R 10K J 1/10W		D9-12			1SS133	DIODE	
R619			RK73GB2A224J	CHIP R 220K J 1/10W		D14-17			1SS133	DIODE	
R620			RK73GB2A222J	CHIP R 2.2K J 1/10W		D18			FCH10A20	DIODE	K2E2M2
R621			RK73GB2A273J	CHIP R 27K J 1/10W		D18			FCH10A20	DIODE	K3
R622			RK73GB2A222J	CHIP R 2.2K J 1/10W		D18			FCH20A20	DIODE	KE1M1
R623			RK73GB2A682J	CHIP R 6.8K J 1/10W		D18			FCH20A20	DIODE	K1
R624			RK73GB2A514J	CHIP R 510K J 1/10W		D19			FRH10A20	DIODE	K2E2M2
R625-627			RK73GB2A332J	CHIP R 3.3K J 1/10W		D19			FRH10A20	DIODE	K3
R629,630		*	R92-5086-05	RS 0.05 2W		D19			FRH20A20	DIODE	KE1M1
R636,637		*	R92-5086-05	RS 0.05 2W		D19			FRH20A20	DIODE	K1
R638			RK73GB2A222J	CHIP R 2.2K J 1/10W		D19			FRH20A20	DIODE	

K : KAC-9152D K1 : KAC-9102D K2 : KAC-8152D K3 : KAC-8102D (North America)
E1 : KAC-9152D E2 : KAC-8152D (Europe) M1 : KAC-9152D M2 : KAC-8152D (Other Areas)

△ Indicates safety critical components.

PARTS LIST

AUDIO UNIT (X09-5820-1x)

Ref. No.	A d d	N e w	Parts No.	Description	Desti- nation	Ref. No.	A d d	N e w	Parts No.	Description	Desti- nation
D23			02DZ16F-Y	ZENER DIODE		Q29,30			2SA1576A	TRANSISTOR	
D25			02DZ16F-Y	ZENER DIODE		Q36			DTC114EUA	DIGITAL TRANSISTOR	
D101			UMZ6.8N	ZENER DIODE		Q37,38			DTA114EUA	DIGITAL TRANSISTOR	
D103-110			1SS133	DIODE		Q41			2SC945AA(Q,P)	TRANSISTOR	
D151			1SS133	DIODE		Q42			2SA992-A(F,E)	TRANSISTOR	
D181		*	02DZ5.1F-Y	ZENER DIODE		Q43			DTA114EUA	DIGITAL TRANSISTOR	
D182,183			1SS133	DIODE		Q151			2SC4081	TRANSISTOR	
D186			1SS133	DIODE		Q187-190			STW34NB20	FET	
D303-307			1SS133	DIODE		Q401,402			2SC3478AA(L,K)	TRANSISTOR	
D308		*	02DZ5.1F-Y	ZENER DIODE		Q403-407			2SA1352(E,F)	TRANSISTOR	K2E2M2
D401-406			1SS133	DIODE		Q403-407			2SA1352(E,F)	TRANSISTOR	K3
D407		*	02DZ15F-Y	ZENER DIODE		Q403-407	*		2SA1352E/F-KEN	TRANSISTOR	KE1M1
D501		*	02DZ5.1F-Y	ZENER DIODE	KE1M1	Q403-407	*		2SA1352E/F-KEN	TRANSISTOR	K1
D501		*	02DZ5.1F-Y	ZENER DIODE	K2E2M2	Q408	*		2SC3415S	TRANSISTOR	
D502			1SS133	DIODE	KE1M1	Q409	*		2SC3902	TRANSISTOR	
D502			1SS133	DIODE	K2E2M2	Q410,411			2SB1427	TRANSISTOR	
D601,602			1SS133	DIODE		Q412	*		2SC3415S	TRANSISTOR	
D603		*	02DZ5.1F-Y	ZENER DIODE		Q413			2SC3902	TRANSISTOR	
D604			1SS133	DIODE		Q414,415			2SB1427	TRANSISTOR	
D605		*	02DZ10F-Y	ZENER DIODE		Q416			2SD1863	TRANSISTOR	
D606			1SS133	DIODE		Q417			2SA1376AA(L,K)	TRANSISTOR	
D607		*	02DZ10F-Y	ZENER DIODE		Q418			2SC3478AA(L,K)	TRANSISTOR	
D904			1SS133	DIODE	KE1M1	Q501			2SC4081	TRANSISTOR	KE1M1
D904			1SS133	DIODE	K2E2M2	Q501			2SC4081	TRANSISTOR	K2E2M2
D906-908			1SS133	DIODE	KE1M1	Q601			2SA1576A	TRANSISTOR	
D906-908			1SS133	DIODE	K2E2M2	Q602			2SC4081	TRANSISTOR	
IC1		*	TL494IDR	ANALOGUE IC		Q603			DTC124EUA	DIGITAL TRANSISTOR	
IC2			BA10358F	ANALOGUE IC		Q604			2SC3478AA(L,K)	TRANSISTOR	
IC11			RC4580IDR	ANALOGUE IC		Q605,606			2SA1376AA(L,K)	TRANSISTOR	
IC12,13			SN74HC00D	MOS-IC		Q607			2SC3478AA(L,K)	TRANSISTOR	
IC31			BA10393F	ANALOGUE IC		Q608			2SA1576A	TRANSISTOR	
IC32			RC4580IDR	ANALOGUE IC		Q609-611			2SC4081	TRANSISTOR	
IC51			RC4580IDR	ANALOGUE IC	KE1M1	TH1			NT732ATTD103J	THERMISTOR	
IC51			RC4580IDR	ANALOGUE IC	K2E2M2						
IC52,53			NJM2172V-TE2	ANALOGUE IC	KE1M1						
IC52,53			NJM2172V-TE2	ANALOGUE IC	K2E2M2						
IC61			RC4580IDR	ANALOGUE IC							
IC62			BA10393F	ANALOGUE IC							
Q1,2			2SC4081	TRANSISTOR							
Q3			2SB1241	TRANSISTOR							
Q4			2SA1576A	TRANSISTOR							
Q5			2SC4081	TRANSISTOR							
Q8,9			2SC4097	TRANSISTOR							
Q10,11			2SA1577	TRANSISTOR							
Q12-14			2SK3662-F	FET	K1						
Q12-15			2SK3662-F	FET	KE1M1						
Q12,13			2SK3662-F	FET	K2E2M2						
Q12,13			2SK3662-F	FET	K3						
Q17-20			2SK3662-F	FET	KE1M1						
Q18-20			2SK3662-F	FET	K1						
Q19,20			2SK3662-F	FET	K2E2M2						
Q19,20			2SK3662-F	FET	K3						
Q25			2SC1845-A(F,E)	TRANSISTOR							
Q26			2SC4883ANF	TRANSISTOR							
Q28			2SA1859ANF	TRANSISTOR							

K : KAC-9152D K1 : KAC-9102D K2 : KAC-8152D K3 : KAC-8102D (North America)
E1 : KAC-9152D E2 : KAC-8152D (Europe) M1 : KAC-9152D M2 : KAC-8152D (Other Areas)

△ Indicates safety critical components.

PARTS LIST

CAPACITORS

CC 45 TH 1H 220 J
1 2 3 4 5 6

- 1 = Type ... ceramic, electrolytic, etc.
- 2 = Shape ... round, square, etc.
- 3 = Temp. coefficient
- 4 = Voltage rating
- 5 = Value
- 6 = Tolerance

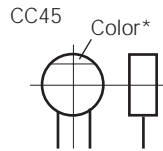

• Capacitor value

- 010 = 1pF
- 100 = 10pF
- 101 = 100pF
- 102 = 1000pF = 0.001μF
- 103 = 0.01μF

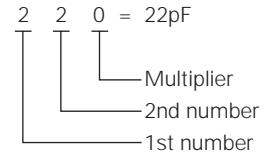

• Temperature coefficient

1st Word	C	L	P	R	S	T	U
Color*	Black	Red	Orange	Yellow	Green	Blue	Violet
ppm/°C	0	-80	-150	-220	-330	-470	-750

2nd Word	G	H	J	K	L
ppm/°C	±30	±60	±120	±250	±500

Example : CC45TH = -470±60ppm/°C

• Tolerance (More than 10pF)

Code	C	D	G	J	K	M	X	Z	P	No code
(%)	±0.25	±0.5	±2	±5	±10	±20	+40 -20	+80 -20	+100 -0	More than 10μF : -10~+50 Less than 4.7μF : -10~+75

(Less than 10pF)

Code	B	C	D	F	G
(pF)	±0.1	±0.25	±0.5	±1	±2

• Voltage rating

2nd word	A	B	C	D	E	F	G	H	J	K	V	
1st word	0	1.0	1.25	1.6	2.0	2.5	3.15	4.0	5.0	6.3	8.0	-
1	10	12.5	16	20	25	31.5	40	50	63	80	35	-
2	100	125	160	200	250	315	400	500	630	800	-	-
3	1000	1250	1600	2000	2500	2150	4000	5000	6300	8000	-	-

CHIP CAPACITORS

(EX) CC 73 F SL 1H 000 J
1 2 3 4 5 6 7
(Chip) (CH, RH, UJ, SL)

(EX) CK 73 F F 1H 000 Z
1 2 3 4 5 6 7
(Chip) (B, F)

Refer to the table above.

- 1 = Type
- 2 = Shape
- 3 = Dimension
- 4 = Temp. coefficient
- 5 = Voltage rating
- 6 = Value
- 7 = Tolerance

• Dimension

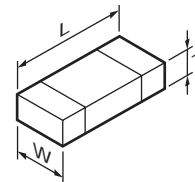

Chip capacitor

Code	L	W	T
Empty	5.6±0.5	5.0±0.5	Less than 2.0
A	4.5±0.5	3.2±0.4	Less than 2.0
B	4.5±0.5	2.0±0.3	Less than 2.0
C	4.5±0.5	1.25±0.2	Less than 1.25
D	3.2±0.4	2.5±0.3	Less than 1.5
E	3.2±0.2	1.6±0.2	Less than 1.25
F	2.0±0.3	1.25±0.2	Less than 1.25
G	1.6±0.2	0.8±0.2	Less than 1.0
H	1.0±0.05	0.5±0.05	0.5±0.05

Chip resistor

Code	L	W	T
E	3.2±0.2	1.6±0.2	1.0
F	2.0±0.3	1.25±0.2	1.0
G	1.6±0.2	0.8±0.2	0.5±0.1
H	1.0±0.05	0.5±0.05	0.35±0.05

RESISTORS

• Chip resistor (Carbon)

(EX) RD 73 E B 2B 000 J
1 2 3 4 5 6 7
(Chip) (B, F)

• Carbon resistor (Normal type)

(EX) RD 14 B B 2C 000 J
1 2 3 4 5 6 7
(Chip) (B, F)

- 1 = Type ... ceramic, electrolytic, etc.
- 2 = Shape ... round, square, etc.
- 3 = Dimension
- 4 = Temp. coefficient
- 5 = Voltage rating
- 6 = Value
- 7 = Tolerance

• Rating wattage

Code	Wattage	Code	Wattage	Code	Wattage
1J	1/16W	2C	1/6W	3A	1W
2A	1/10W	2E	1/4W	3D	2W
2B	1/8W	2H	1/2W		

SPECIFICATIONS

Audio Section

Max Power Output	
KAC-9152D	1800W
KAC-9102D	1700W
KAC-8152D/8102D	1100W
Rated Power Output (+B=14.4V)	
(4Ω) (20Hz~200Hz, 0.5% THD)	
KAC-9152D/9102D	500W x 1
KAC-8152D/8102D	300W x 1
(2Ω) (100Hz, 0.9% THD)	
KAC-9152D	900W x 1
KAC-9102D	850W x 1
KAC-8152D/8102D	550W x 1
(1Ω) (100Hz, 1.0% THD)	
KAC-9152D	900W x 1
Frequency Response (+0, -3dB)	5Hz~200Hz
Sensitivity (rated output)	
MAX	0.2V
MIN	5.0V
Input Impedance	10kΩ
Signal to Noise Ratio	≤96dB
Low Pass Filter Frequency (24dB/oct.)	50~200Hz (variable)
Infrasonic Filter Frequency (18dB/oct.)	15/25Hz
Phase Inverter	0° (Normal)/180° (Reverse)
Bass Boost Circuit	0~18dB (variable)
Bass Boost Frequency	
KAC-9152D/8152D	40~100Hz (variable)
KAC-9102D/8102D	40Hz

General

Operating Voltage	14.4V (11~16V allowable)
Current Consumption	
KAC-9152D/9102D	60A
KAC-8152D/8102D	40A
Installation Size (W x H x D)	380 x 61 x 286mm
Weight	
KAC-9152D	5.8kg
KAC-9102D	5.7kg
KAC-8152D	5.6kg
KAC-8102D	5.5kg

KENWOOD follows a policy of continuous advancements in development. For this reason specifications may be changed without notice.

Installation

